

Inventing for Coating & Sizing

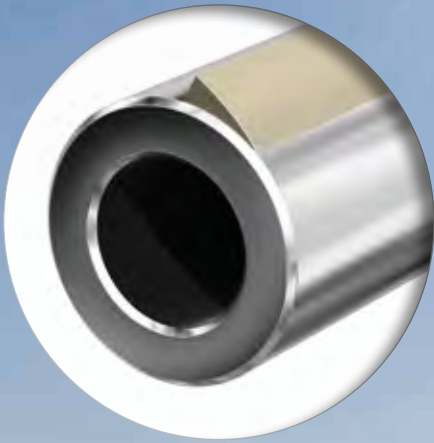

Reliable Innovation

Applied state-of-the-art Innovation is in our DNA

The best thing about
UMV is that they
understand our needs!



*Psst,
ambitious
papermakers!*

Index

- | | | |
|---------------------------------|---------------------------|---------------------------------|
| 2. Reliable Innovation | 12. ABC™ Coater | 22. Pilot Plant |
| 4. INVO® Tip Metering Element | 14. TWIN™ Sizer | 24. Customer Service |
| 6. INVO® Coater | 16. Combination Machinery | 25. UMV in the Circular Economy |
| 8. Our Innovation Drivers | 18. LAS® | 26. About UMV & Company History |
| 10. Sustainable Barrier Coating | 20. TWIN ABC™ | 28. Contact |

Our Approach

Measure & Define

- Material Yield
- Uptime
- Speed Utilization
- Energy
- Automation



Competitive Edge

- Attractive Offering to Your Customers
- Benchmark Efficiency
- Sustainability in the Circular Economy

Streamlined Process Design

- Concept Design
- Pilot Testing
- Review Concept
- Agree Solution

INVO® Tip Metering Element

Realizing the Greatest Savings Potential in Coating



INVO® Tip Offers Both Excellent Fibre Coverage and Improved Smoothness

- Excellent fiber coverage and smoothness
- Improved print quality
- Increased production
- Energy savings
- Higher dry content
- Cost reduction due to cheaper raw material
- Excellent lifetime, runnability and coat weight control
- Fits all of the existing coaters on the market
- Offers excellent barrier properties
- Less fiber and/or chemicals

Board Mill Using INVO® Tip from UMV. Total investment less than € 100.000. Savings of about € 5 million/year.

UMV has developed an innovative and cost-saving metering element, the INVO® Tip. The INVO® Tip is a soft polymeric metering element that provides extremely consistent coverage and smoothness while reducing operating costs.

A polymeric tip must never run dry against the sheet since it will burn and all benefits are lost. UMV has solved this issue with the patented and award-winning design of the INVO® Tip. UMV now makes this unique product, the INVO® Tip, available to all customers.

Experience from INVO® Tip mills, shows that it is possible to achieve substantial savings in feedstock, coating color and energy with equal or better quality by using the INVO® Tip.

Many mills are using conventional, energy-consuming techniques, such as air-knife and curtain coater, to achieve good fiber coverage. INVO® Tip can do the job and substantially reduce energy consumption and increase production output. Additionally, it is possible to utilize a cheaper coating color giving equal or better coating quality than before.

INVO® Tip can be installed in all existing coaters.

Cost Cutting Through

- Less bleached fibers needed in top layer
- Less and/or cheaper coating
- Less energy

Growth Opportunities

- New optimized grades
- Increased output

Field Experience

1. 25% saving on coating color
2. 20% saving on bleached fibers
3. 10% saving on drying energy
4. 10% increased output

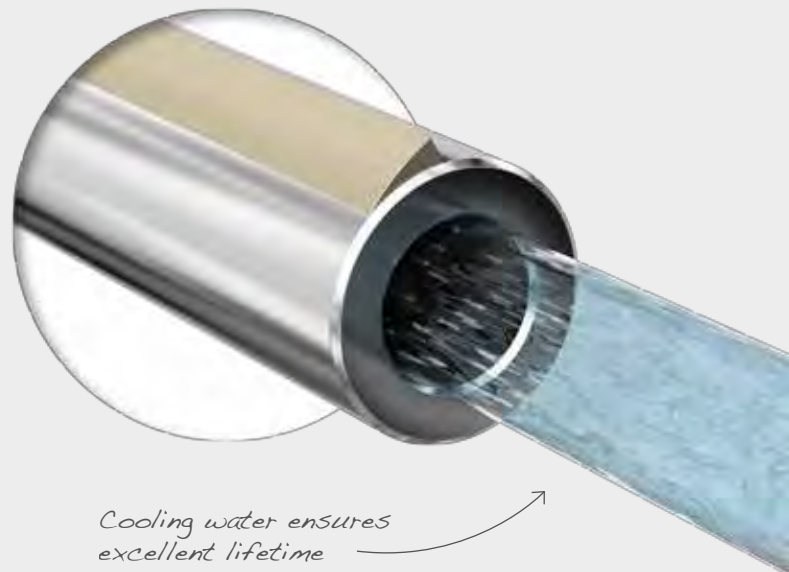

Example of Print Results



21 gsm total coat weight, with blade



17 gsm total coat weight, with INVO® Tip

INVO[®] Coater

This is the Unique Zero Dwell Coater

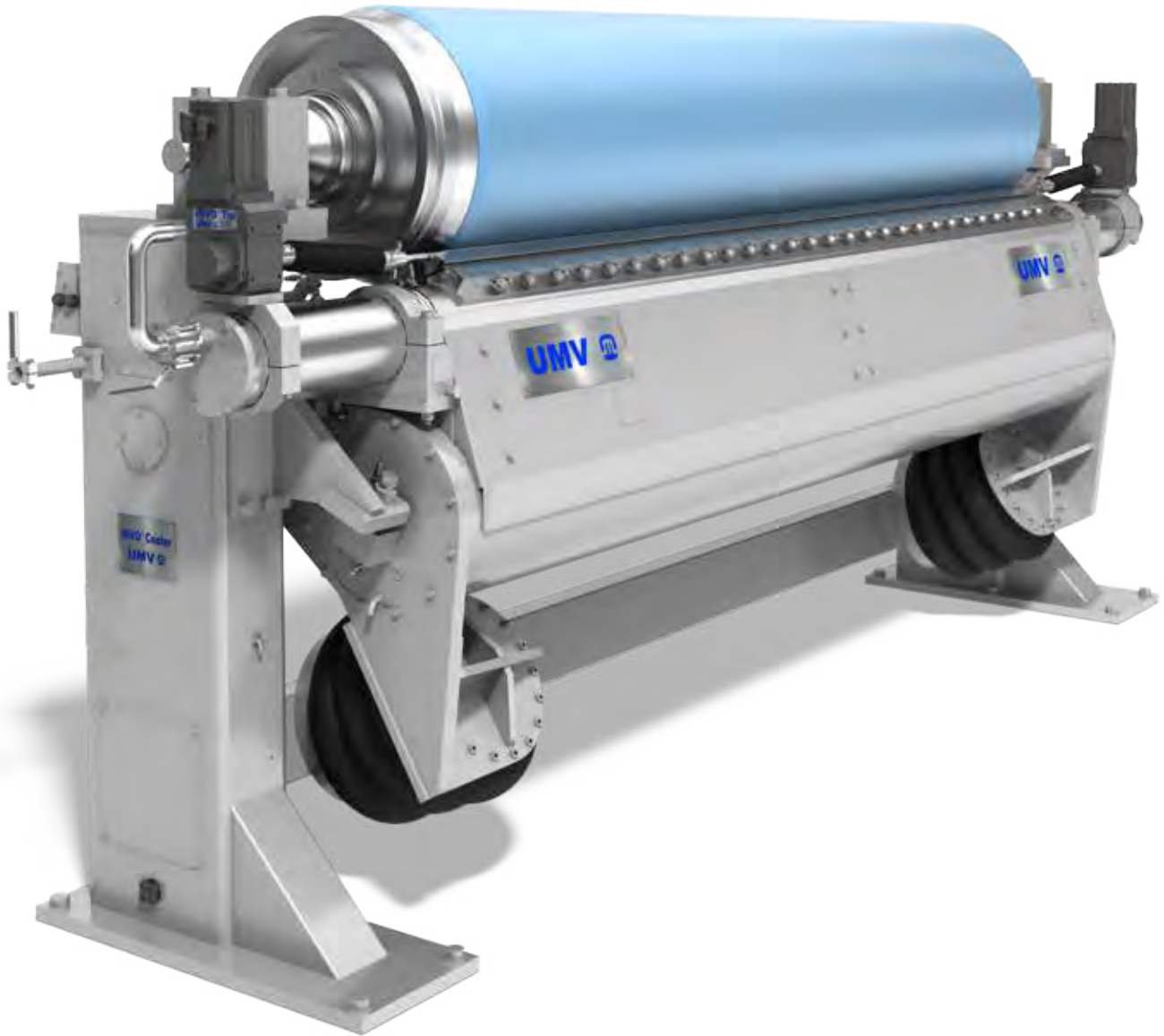

Zero Dwell Application

Features

- Base paper retains its strength during the coating operation
- Surface-located treatment
- Higher solids for same coat weight

Benefits

- Excellent runnability
- Excellent coverage and possibility to reduce coat weight
- Energy saving
- Excellent barrier coater
- Uniform application without any vortex problems

UMV has set a New Standard with this Zero Dwell Coater

INVO® Coater from UMV is one of the best inventions since the start of coating and sizing. It follows the innovative tradition of UMV with several proven state-of-the-art technologies in the offering, such as the INVO® Tip metering element and the ABC™ Coater.

The INVO® Coater is a compact combination of a Jet Coating Applicator with a system for conventional rod or INVO® Tip metering. In this way, the application and metering of the coating color takes place with minimum dwell time, which offers the possibility to run with high solids in both starch and coating color applications.

The applied media stays on the surface of the sheet and reduces coat weight needs while giving you excellent coverage.

The possibility to apply thin coating layers with a low wet amount makes this coater an excellent choice for barrier applications.

It can be used for both front- and reverse side treatment in numerous combinations and set-ups.

Can be equipped with either a manual or an Automatic Profiling System. Because of its design, it is perfectly suited for retrofits, which often have space limitations.

Design

Features

- Compact
- Modular
- Versatile

Benefits

- Can easily be installed in a confined space
- Several machines can be installed in sequence, allowing for a larger number of coating layers within the same space

INVO® Coater Mill Case Examples:

- Replacing Airknife coaters
- Reverse side treatment, board production
- Top side treatment, board production
- Multiple barrier layer coating
- Coating of low basis weight/weak web
- Vortex free, zero-dwell coater

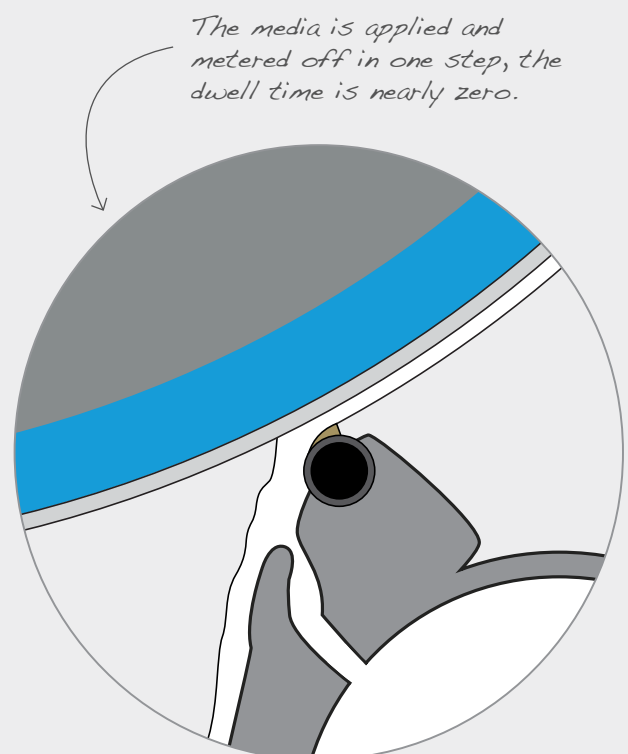

Our Innovation



Less
Feedstock



Le
Coating

Inventing for
Increased Output /
Equal or
Based on More than

Market Needs &

tion Drivers



ss
Media



Less
Energy

Coating & Sizing

Resource Unit with
Better Quality

50 Years of Experience

Operational Excellence

Sustainable Barrier Coating

Combining INVO® Coater & INVO® Tip with a Light Touch of Drying creates Excellent Barriers

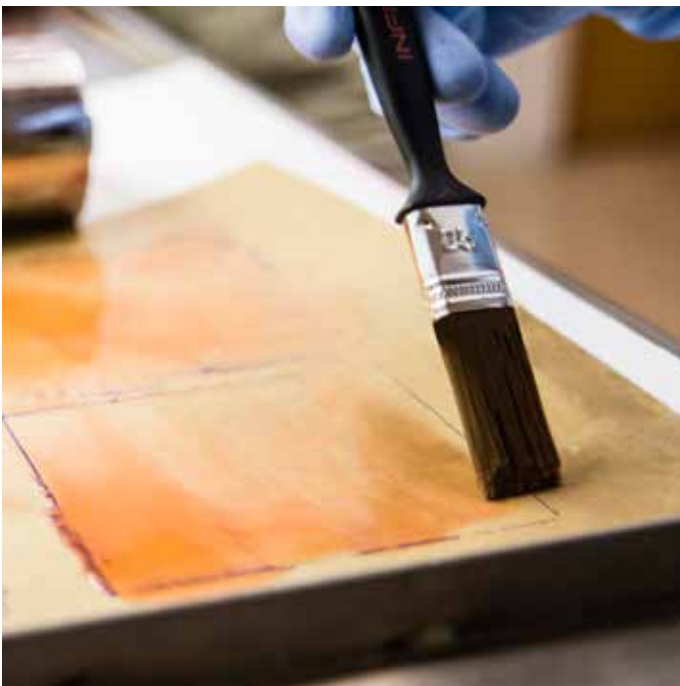

Capital & Running Cost can be Reduced to a Fraction of Competing Technologies

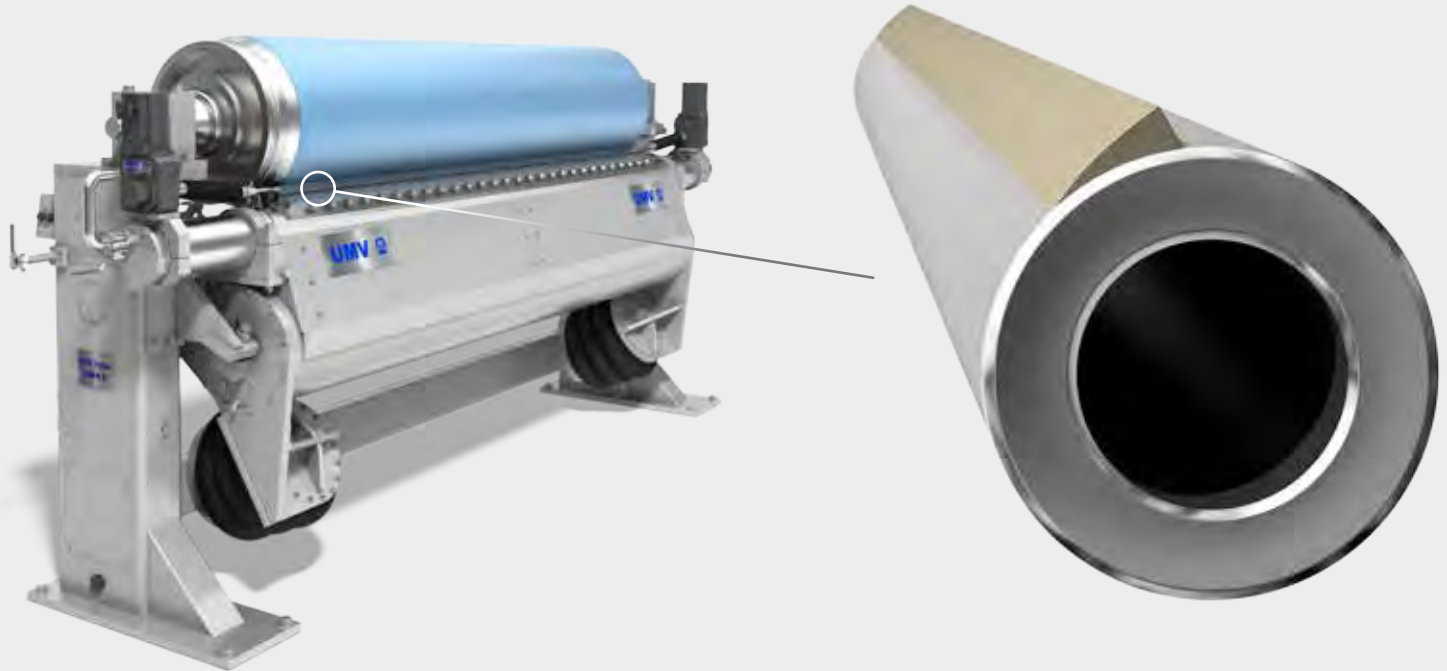

The Paper and Board industries are seeking a working, effective and sustainable barrier technology with reasonable capital and running costs.

UMV has another approach to this: Multiple Barrier Coating with thin layers. After successful trials at the UMV Pilot Plant in Säffle, Sweden, the conclusion is rock solid. The concept is proven and is based on the combination of the zero dwell INVO® Coater and the resilient INVO® Tip metering element.

By using the UMV set-up for sustainable barrier coating, the capital costs can be reduced to a fraction of competing technologies.

The running costs are also favorable as UMV achieves full barrier with only a few gsm of coating media applied.

We allocate major resources to the field of barrier coating. Recent upgrades have ensured that the pilot plant can now also offer the best conditions for barrier applications.

Features:

- Two coating stations, each equipped with drying
- Cooling cylinder prior to pope reel
- Web temperature monitoring system

Benefits:

- The interaction between different layers can be optimized
- Control of web temperature
- No blocking



ABC™ Coater

Benchmark Efficiency & Flexibility

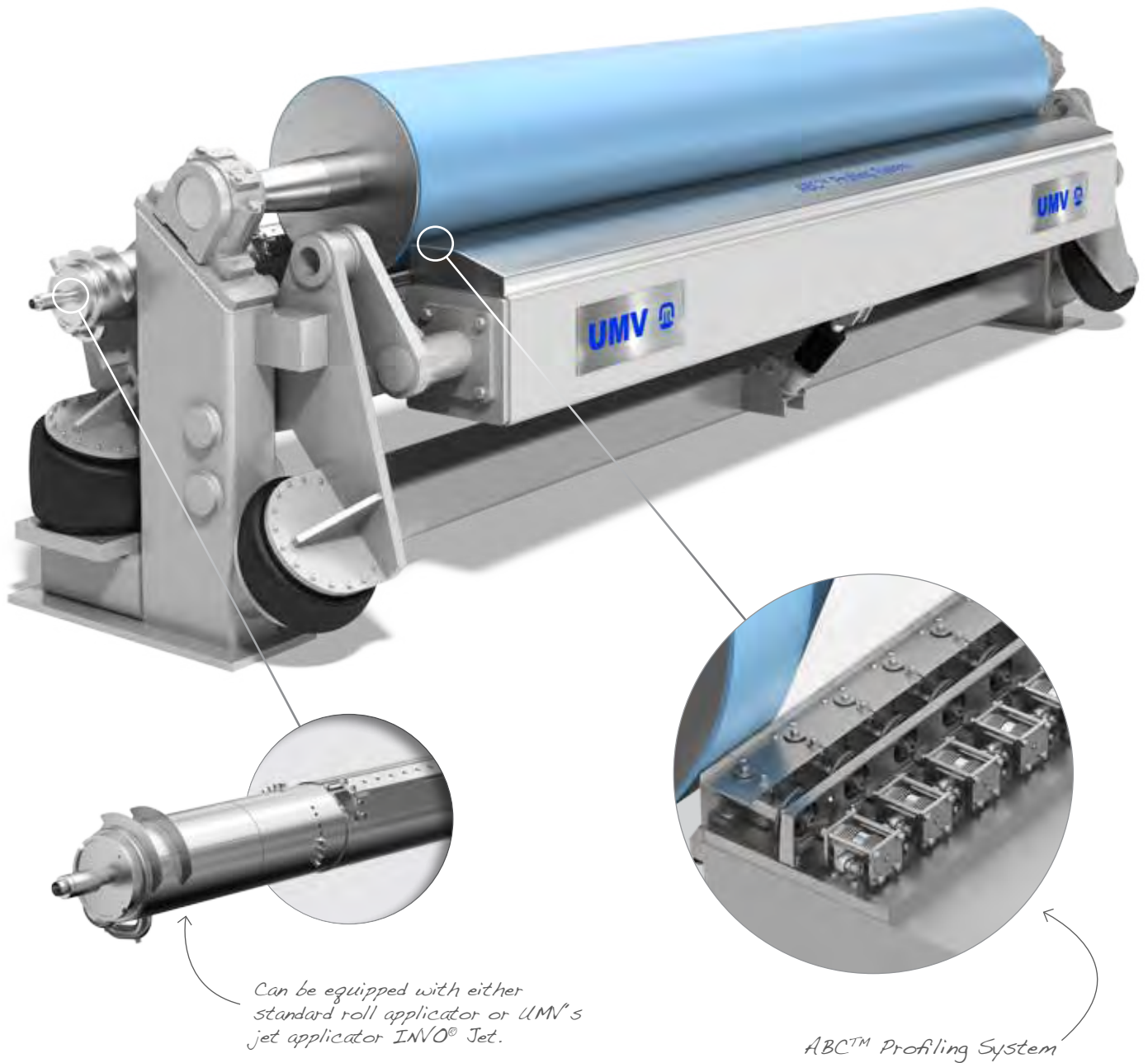

ABC™ Coater with Excellent Runnability

- Roll or Jet Application
- Metering methods:
 - True stiff blade
 - Stiff blade
 - Bent blade
 - Rotating rod
 - INVO® Tip

ABC™ Coater Profiling Options:

- ABC™ Pneumatic System in Automatic or Manual mode
- Conventional profiling mode, by means of electric step motors or manual set screws

ABC™ Pneumatic Profiling

The system is based on the principle of the backing roll providing the reference point for the profiling system. This means that interference from the blade holder position or movement is eliminated. The result of this principle is a self-positioning system that delivers uniform and excellent profiles right from the start of the coating process.

The ABC™ control mechanism is reliable and developed to withstand the harsh environment in the coating machine. The control actuators are made of acid-proof stainless steel.

The first actuator of this type was installed in 1998 and they have proven to be maintenance-free.

Benefits of ABC™ Pneumatic Profiling:

- Immediate flat cross-direction profiles
- Repeatable and uniform quality
- Allows for quick grade changes
- Large coat weight range with uniform profiles also when applying high coat weights

ABC™ Profiling in Manual Mode (without QCS link)

The ABC™ system delivers excellent profiles also in manual mode due to the self-positioning. This is shown by the initial 2-Sigma values that are achieved. The product is in quality already from the start.

CD CW 2-Sigma (gsm)

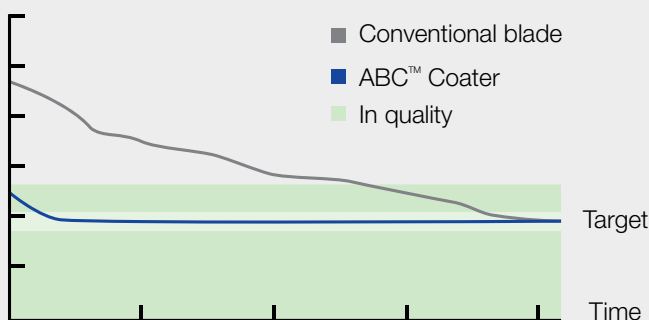

Chart showing the 2-Sigma value over time. The first 2-Sigma value from the scanner is normally twice as good compared to a conventional system.

ABC™ Profiling in Automatic Mode (with QCS link)

The ABC™ profiling can be linked to the QCS system, the final result is based on the capability and quality level of the QCS system.

MD CW (gsm)

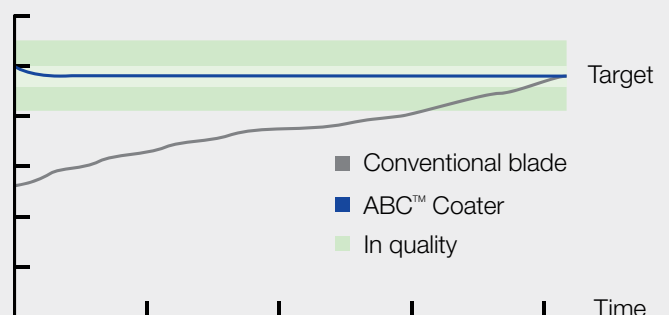

Chart showing the repeatability of the ABC™ System. The settings from previous production are valid.

INVO® Jet Applicator

Features:

- Complete double-walled design, including slice lips
- On/Off by rotation, full jet flow in standby position
- The most compact applicator on the market

Benefits:

- Minimal cleaning required, no additional downtime
- From standby to coating mode within one second, for maximized output
- Easy replacement of existing applicators

TWIN™ Sizer

Customized to Your Needs



UMV provides board- and paper makers with the entire range of TWIN™ Sizer solutions, from sizing and pigmenting to coating applications.

UMV has a wide product portfolio and can offer all levels of film transfer machines, depending on customer needs. Rod, Gravure or HSM pre-metering methods, creates a thin film of size or coating color on the transfer rolls.

The film is then applied onto both sides of the paper or board in the transfer nip. The choice of pre-metering method depends on the base paper, end product quality and coating formulas.

TWIN™ Sizer for Excellent Runnability and High Product Quality

TWIN™ Sizer, Rod

Rod pre-metering is the conventional method to achieve a film transfer by utilizing grooved or smooth rod as the metering element.

The coat weight is determined by the rod design.

TWIN™ Sizer, Gravure

Gravure pre-metering based on the well-known Roto-Gravure technique and introduced to the paper- and board industry by UMV.

The coat weight is easily controlled by adjusting the Gravure roll speed.

TWIN™ Sizer, HSM

A unique technology developed by UMV where a wire wound roll is used as the metering device.

The coat weight is determined by the wire diameter.

To be Equipped with Your Preferred Pre-metering Technology

TWIN™ Sizer from UMV can be Equipped with the Metering Technology of Your Choice:



TWIN™ Sizer, Rod

Rod pre-metering is a well-proven technology that gives you benchmark performance for standard coating/sizing needs.

This unit also offers additional unique possibilities:

- Pond size press
- Direct coating
- Direct coating with reverse film transfer

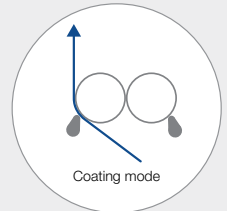
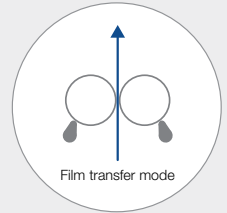

TWIN™ Sizer, Gravure

This state-of-the-art technology is the perfect solution for production lines with frequent grade changes and the need for accurate coat weight control.

The extraordinarily large operation window allows for extremely high or low coat weight at any speed, not achievable by any other technology.

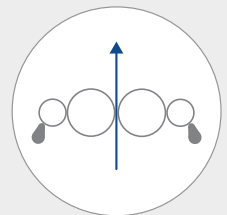
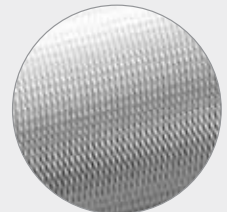

TWIN™ Sizer, HSM

The method of choice for specific applications.

- High wet amounts
- High coat- or sizing amounts
- Demanding substrates and media

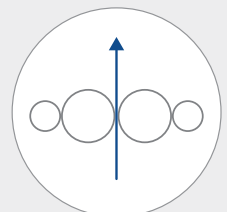
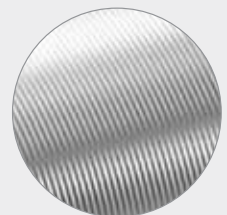

Combination Machinery

Based on a Standardized & Compact Module with Unlimited Combination Possibilities

UMV combination machinery enables you to run in numerous modes while keeping efficiency at a benchmark level.

The combination machines are customized to your needs with high availability and efficiency as they are built on proven technology with our high-performance standard modules.

Because of the compact and versatile design of the module, the combination machines can fit in any production line. **What are your needs?**

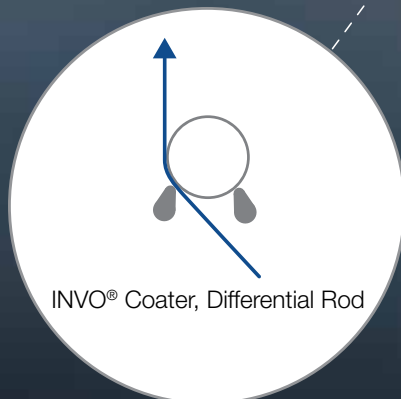

Combination Machinery Gives You Flexibility to Meet the ever-changing Needs of the Market

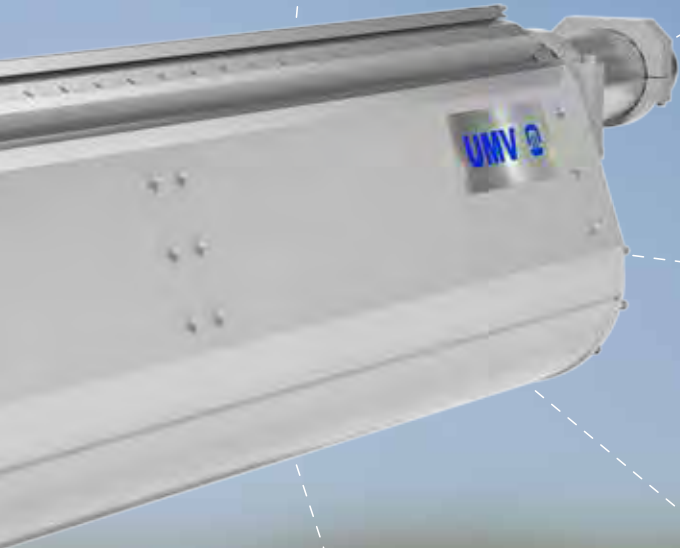
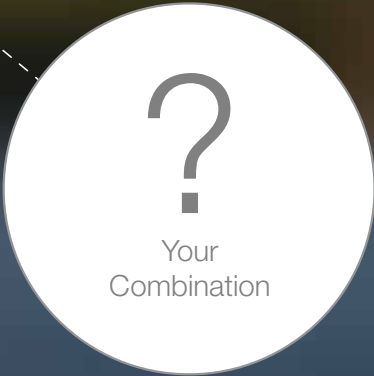
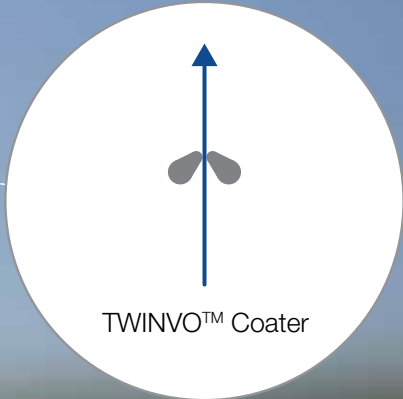
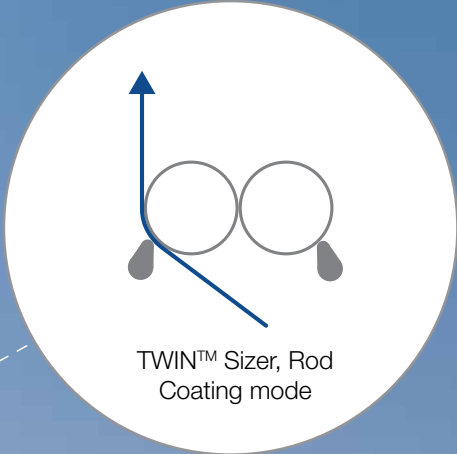
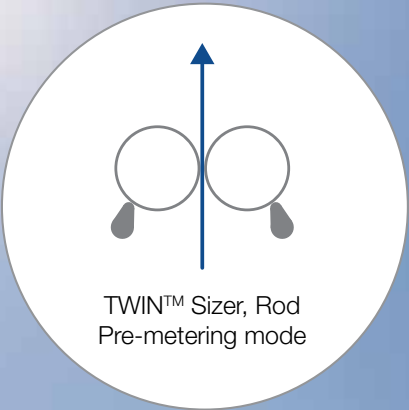

LAS[®]

Decurler & Moisturizer

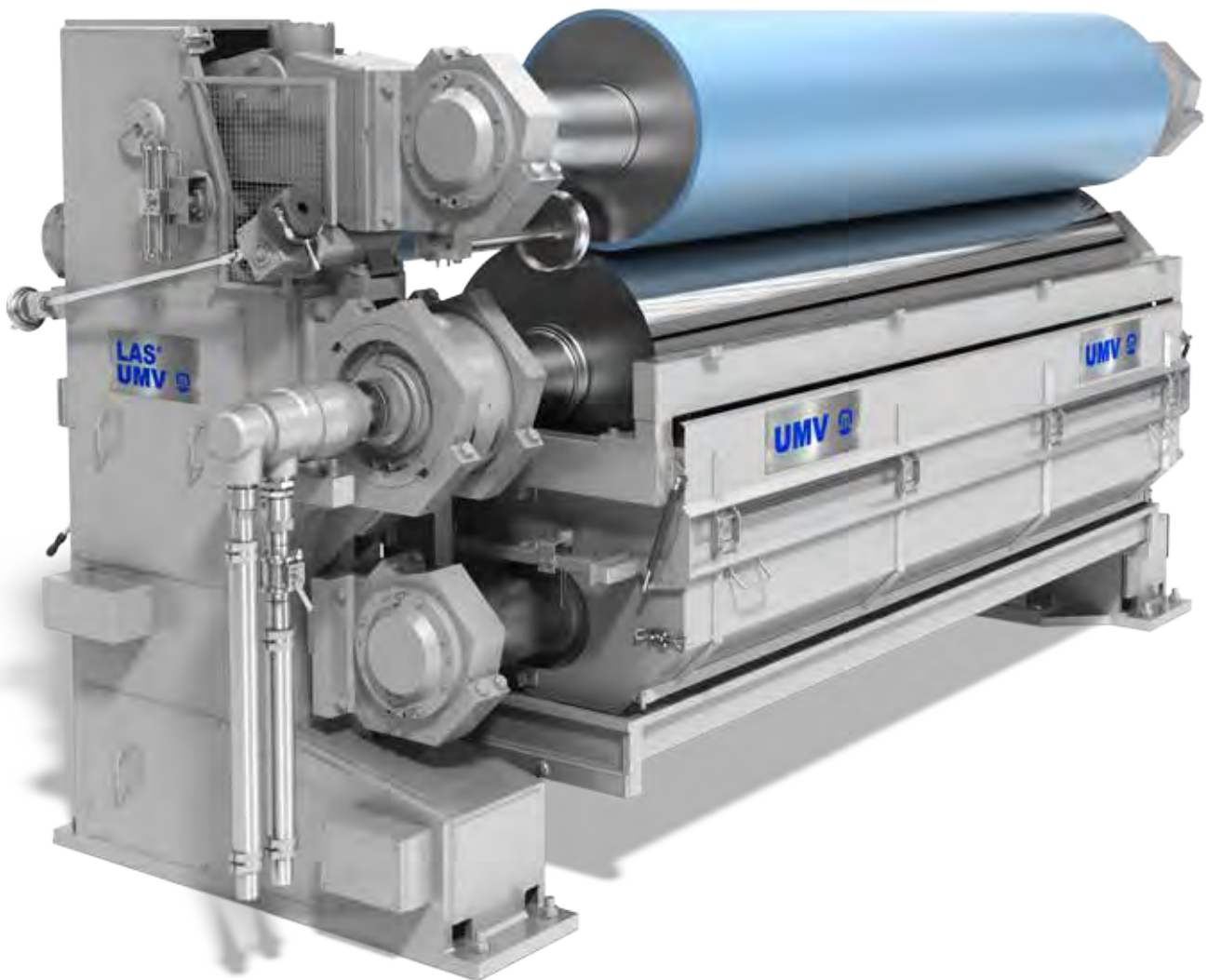

LAS[®]

Features:

- Decurling is achieved at minimal application
- Hydrophilic chrome-plated transfer roll
- Pickup controlled by transfer roll speed
- Minimal recirculation rate
- Horizontal, vertical or angled for optimal layout
- No consumables or wear parts

Benefits:

- Less or no drying needed for Decurling
- Accurate controllability
- Large operation window, from 0 up to extreme amounts.
- Predictable and repeatable results
- Runs from low to high speeds > 2 000 m/min
- Runs with close to no attention from operators
- Low maintenance

The LAS[®] Operating Window is Now Available to Speeds Well Above 2 000 m/min

The LAS[®] (Liquid Application System) is a unique hydrophilic roll coater, decurler and moisturizer that applies a pre-metered liquid film to the web. It can apply media from water to high solids pigment coatings onto high grammage boxboard to lightweight tissue.



Flow Dynamic

The LAS[®] Moisturizer and Decurler is a well-proven technology with more than 200 installations in the Paper-, Board- and Converting Industries worldwide.

The primary application is moisturizing linked to converting and decurling of single-sided coated paper and board. It can also be utilized for surface sizing and pigmenting.

Layout

The LAS[®] can be installed in horizontal, angled and vertical design for the optimal layout. Because of the low maintenance and monitoring requirements, it can be installed in positions with limited access. Basement or upper floor is often used.

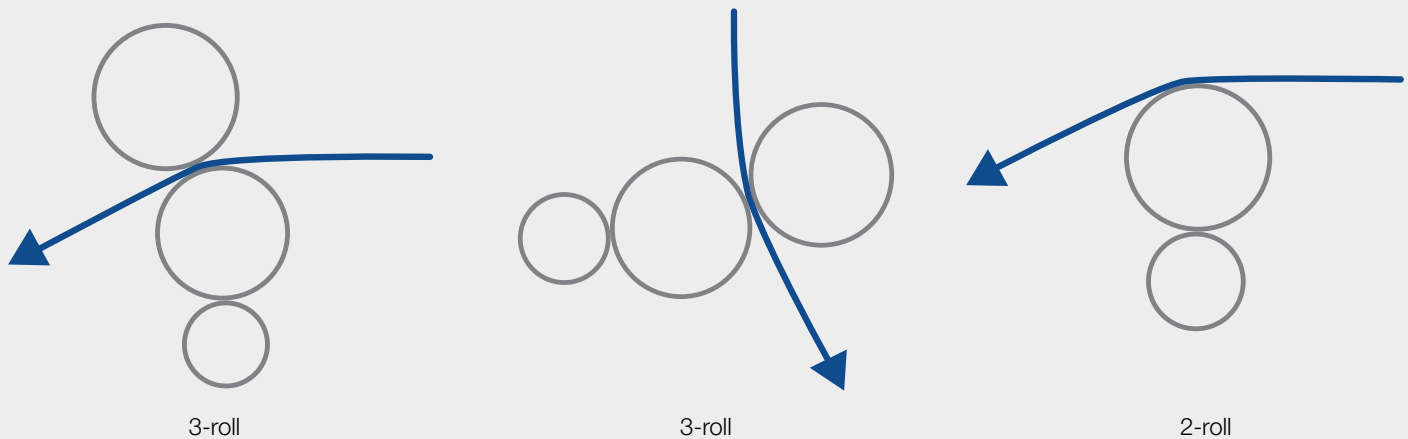

Functionality

The applicator roll brings the water/liquid from the pan to the metering nip. The hydrophilic transfer roll meters the media to the web, with or against the web direction. The transferred amount of coating/media is controlled by the speed of the hydrophilic roll, that is, increased velocity results in an increased applied amount.

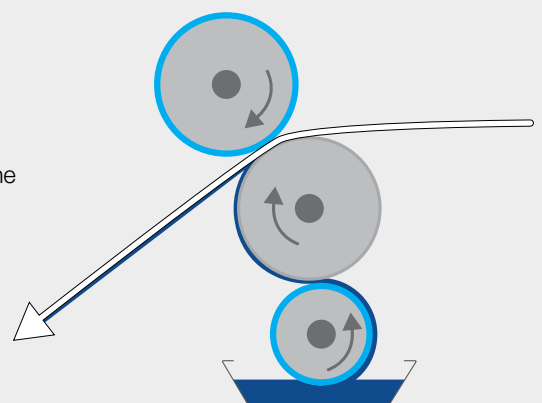

TWIN ABC™

The Only Double-sided Blade Coater on the Market



The only double-sided coater that gives excellent smoothness, meaning no film split. This coater can apply up to 25 gsm per side, i.e., the job of 4 blade coaters.

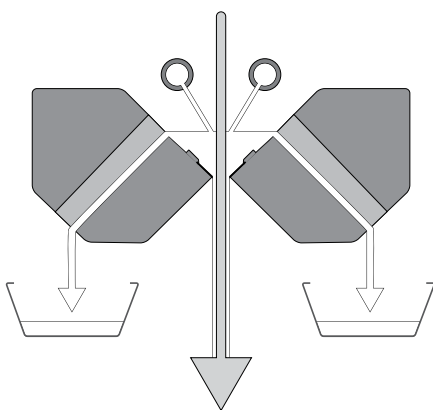

TWIN ABC™ in a Downward Web Run

In a downward web run, the blades come together forming a V-shaped pond with the web running vertically down between them. The coating pond, with a full-width overflow system, applies coating evenly to the paper surface with an absolute minimum recirculation rate. Piping, filters and pumps can be dimensioned accordingly. This method is ideal for simultaneous double-sided coating.

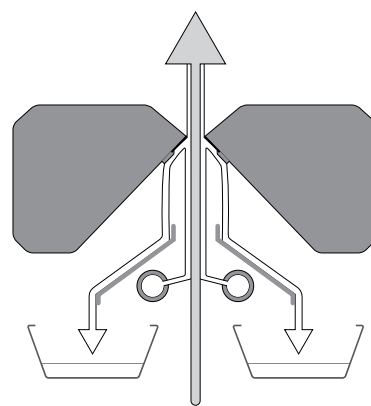

TWIN ABC™ in an Upward Web Run

The TWIN ABC™ in an upward layout can be utilized for both differential and double-sided applications. The coating color is added by Jet applicators on each side of the web, the benefit being perfect side-to-side color separation.

TWIN ABC™ executes the blade coating process on both sides of the web in a single step. This is achieved by positioning two blades as mirror images of each other, one on each side of the paper web, with their tips separated only by the thickness of the web.

The ABC™ principle loads the blades at the very tip, keeping them completely straight during all phases of operation and at all blade pressures and angles. Since the blades never bend, the position and angle of each blade tip is always known and under accurate control with precise alignment and repeatability.

The profiling is achieved by adjusting the blade pressure of one of the blades against the other. The individual pneumatic actuators across the width of the web ensure a uniform profile.

With equal and simultaneous wetting of the paper or board on both sides, the subsequent drying does not produce the stresses that cause curl.

Giving You New Opportunities

By the addition of one coating layer, new opportunities are available within existing coating sections.

The TWIN ABC™ total installation cost could be estimated to one third compared to installing two new coating stations.

Maintenance requirements are also substantially less as the TWIN ABC™ does not need any rolls or drives.

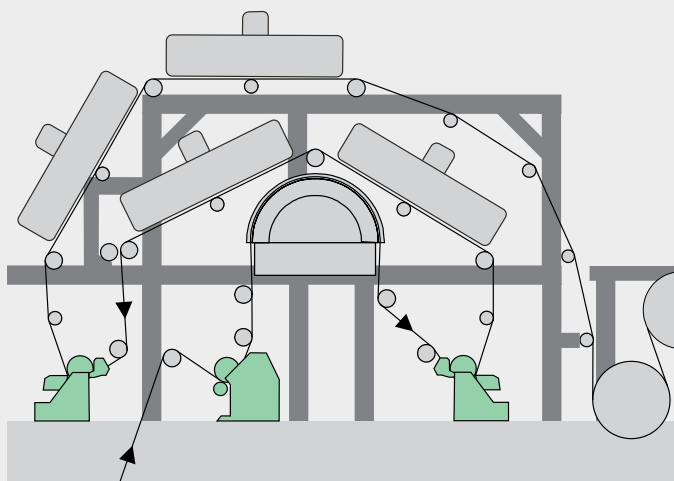

Existing: 2+1 coating layers

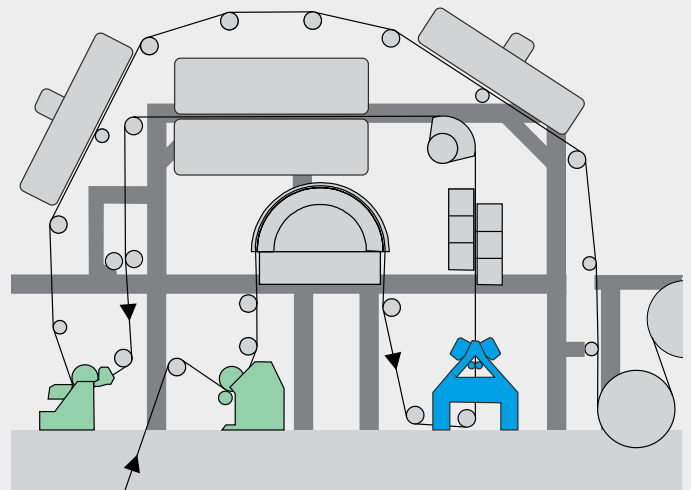

Future: 2+2 coating layers within the same machine space

We Welcome You ...

... to One of the World's Most Advanced Pilot Coating Facilities!



a Selection of Configurations – Modules to be Combined into Your Future Concepts

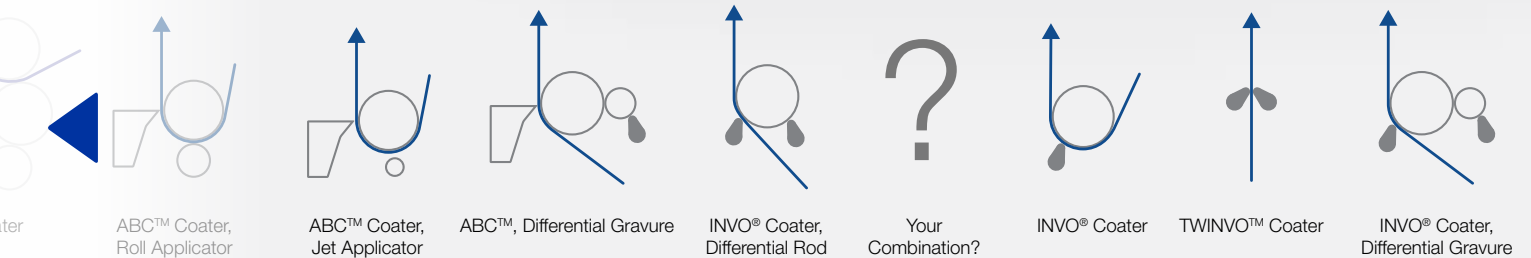

Take Off with Our Pilot Crew into Your Future

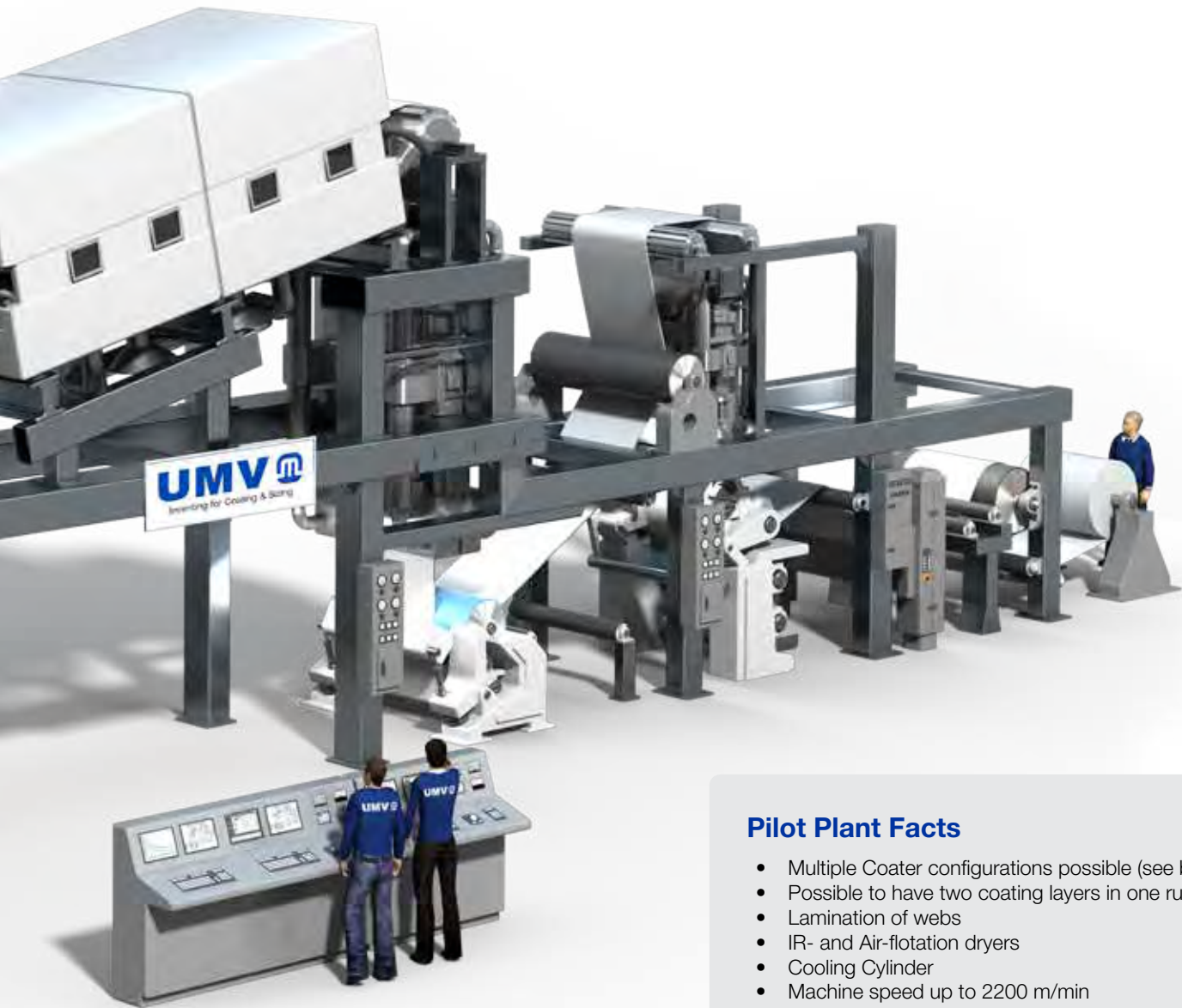

Pilot Plant Facts

- Multiple Coater configurations possible (see below)
- Possible to have two coating layers in one run
- Lamination of webs
- IR- and Air-flotation dryers
- Cooling Cylinder
- Machine speed up to 2200 m/min
- Web width up to 600 mm
- QCS Scanners and temperature gauges at all critical positions for data collection

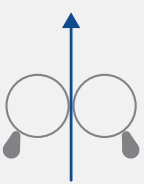

TWIN™ Sizer, Rod

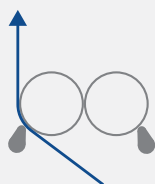

TWIN™ Sizer, Rod Coating Mode

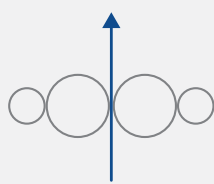

TWIN™ Sizer, HSM

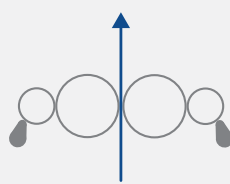

TWIN™ Sizer, Gravure

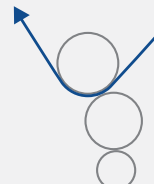

LAS®



TWIN ABC™



TWIN ABC™



Coat

Customer Service



**Excellence in service to our customers is more than important to UMV.
This ensures a long-lasting partnership, bringing your coating and sizing operations to the next level.**

-
- | | | |
|----------------|---------------------|-----------------|
| Capital Spares | Tailor-made Service | Consultancy |
| Minor Spares | Training | Process Studies |
| Consumables | Maintenance | Upgrades |

UMV Coating Systems Provides Spare Parts for Equipment Supplied by:

- Inventing AB
 - UMV Machinery AB
 - Dahlgrens International Inc
 - BTG UMV Coating AB
 - BTG Coating Systems AB
- UMV Coating Systems

UMV in the Circular Economy

Our Coating & Sizing Systems spring from the conviction that there is always a better and more sustainable solution for us to offer you, while improving the overall efficiency of your operation and business.

We Deliver the Technology that Gives You the Competitive Edge

Our innovation drivers:

Less Feedstock, Less Coating Media and Less Energy.

Reduce your expenses and also your
environmental footprint.



Less
Feedstock



Less
Coating Media



Less
Energy

UMV Coating Systems

Inventing for Coating & Sizing

With a strong customer focus and a business DNA built on innovation and reliability, UMV Coating Systems has become the global technology leader in the development and supply of surface treatment technology to the coated paper and board industries.

The UMV Coating Systems range of products and services includes all of the equipment and know-how necessary for complete coating solutions.

In addition to advanced equipment for single or double-sided surface sizing, pigmentation and coating, UMV Coating Systems takes responsibility for complete coating sections, including pre-study, design, manufacture, installation supervision, training, startup and continuous improvement.

INVO® Coater and INVO® Tip are the latest of many unique products from UMV Coating Systems.

Benchmark coating profiles are the result of the ABC™ Profiling System that fits in any coater. TWIN ABC™ is compact and coats two sides simultaneously – and now INVO® Tip, the energy-saving and production-boosting metering element for excellent fiber coverage, print quality coverage and barrier properties.

UMV Coating Systems has world-leading expertise within Coating and Sizing for the Board and Paper Industry. This comes from more than 50 years of global experience with over 600 installations. We serve demanding customers with innovative and cost-saving technologies, consumables and machinery. At our cutting-edge Pilot Plant our crew is at your disposal.

1962 The start of Billblade, the first application in the world for production of 2-sided coated paper in a single-coating station

1978 First pilot machine

1986 LAS patent is acquired from Dahlgren International Inc

1989 First delivery of HSM system

1993 First delivery of ABC™ system

1968 Bonnier Group founds AB INVENTING

1973 First installation of Billblade-Differential for 2-sided coated paper with different coating colors

1985 New pilot machine, maximum machine speed 1 500 m/min

1987 The company changes name to BTG Coating Systems AB

1992 AGIV AG buys BTG and founds Spectris AG, which owned HBM, Bruel & Kjeaar and BTG



UMV Coating Systems is Certified According to ISO 9001:2008

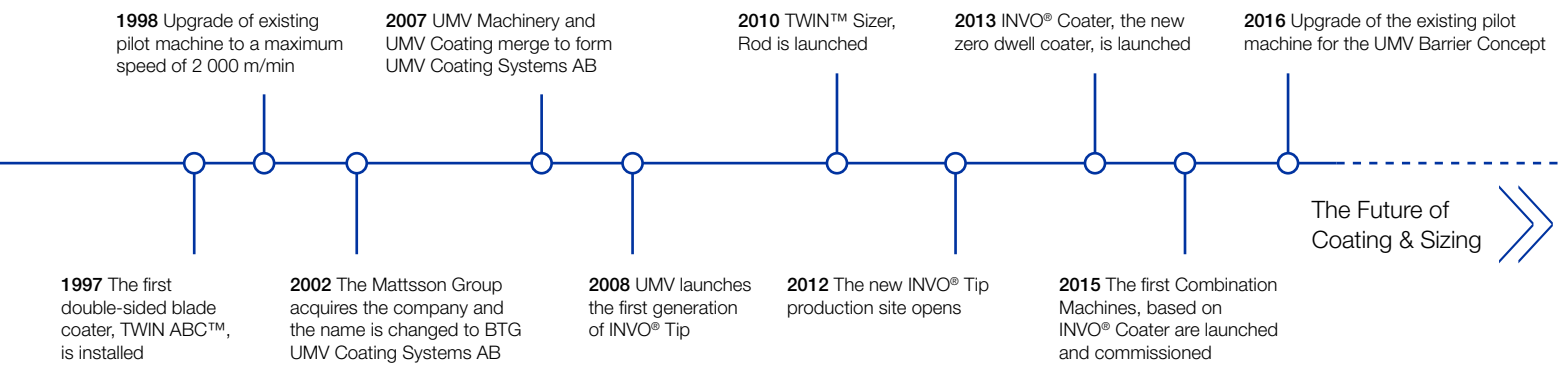

UMV Coating Systems is a member of the Swedish Mattsson Group of Companies. In addition to UMV Coating Systems, the Mattsson Group consists of well positioned companies within Mechanics, Marine Engineering and Real Estate.

Read more at mattsson.se

Street Address

Industrigatan 7
SE-661 32 Säffle
Sweden

Mailing Address

PO Box 162
SE-661 24 Säffle
Sweden

GPS

N 59.129670
E 12.909878

+46 522 982 80

info@umv.com
sales@umv.com
firstname.lastname@umv.com

www.umv.com



UMV Global Reach



 UMV HQ  UMV Agents & Distributors