

Contact Details

Before using the product, please check the guide pages at the front of this catalog.

Internet

<http://www.daikinpmc.com/en/>

For latest information, PDF catalogs and operation manuals

02 Series Stacking Type Port P/T Throttle Valves

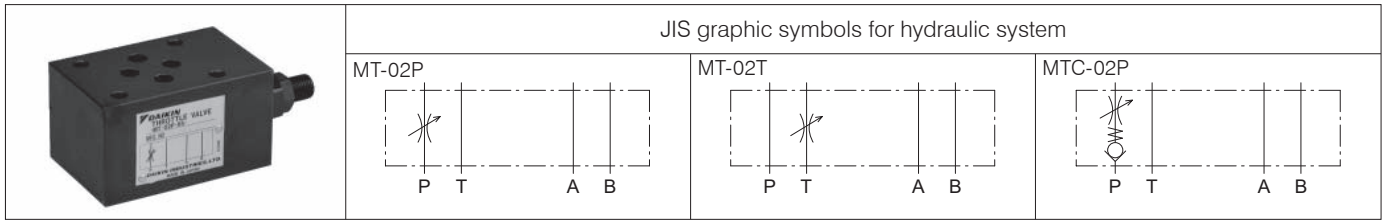

Nomenclature

1 2 3 4 5 6 7 8

1 Applicable fluid code

No designation: Petroleum-based hydraulic fluid, water-glycol hydraulic fluid

F: Phosphate ester hydraulic fluid

2 Model No.

MT: Modular stacking type throttle valve

3 Check valve code

No designation: Without check valve

C: With check valve

4 Nominal diameter

02: ¼

5 Control port

P: Port P

T: Port T

6 Design No. (The design No. is subject to change)

55: MTC-02P

65: MT-02*

7 Pressure adjusting screw position

No designation: Adjusted at port B side

G: Adjusted at port A side

8 Option code

No designation: Flow rate adjusting screw type

T: Flow rate adjusting handle type ^{*1}

Note: ^{*1} The flow rate adjusting handle type cannot be selected for MTC models.

Specifications

Model code	Maximum operating pressure MPa {kgf/cm ² }	Maximum flow rate L/min	Check valve cracking pressure MPa {kgf/cm ² }	Mass kg
MT-02*-65	35 {350}	40	—	0.9
MTC-02P-55	25 {250}		0.04 {0.4}	1.0

Handling

- The flow rate will not be zero even if the flow rate adjusting screw is fully tightened.
- With the throttle valve for port T, maintain the back pressure at the tank port of the solenoid valve within the permissible range.

Performance curves (viscosity: 32 mm²/s {cSt})

Pressure drop characteristics

MT-02P(T)-65

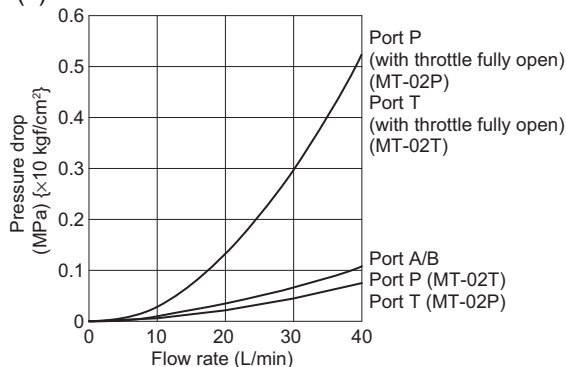

MTC-02P-55

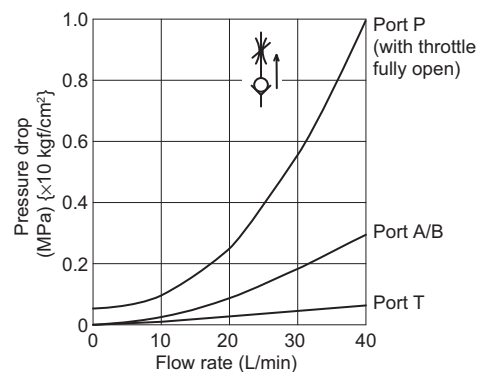

Flow rate adjusting screw revolution - Flow rate characteristics

MT-02P(T)-65

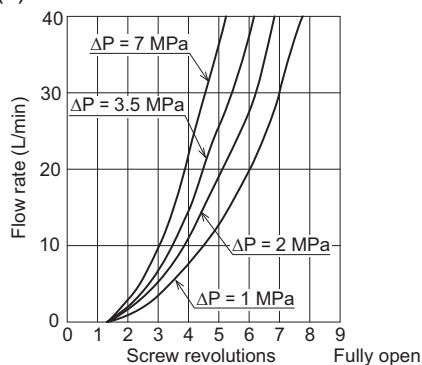

MTC-02P-55

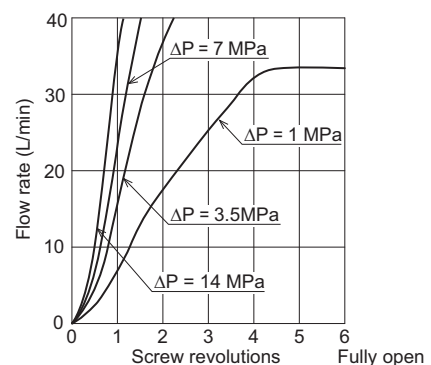

Contact Details

Before using the product, please check the guide pages at the front of this catalog.

Internet

<http://www.daikinpmc.com/en/>

For latest information, PDF catalogs and operation manuals

External dimension diagram

MT-02P, T
MTC-02P

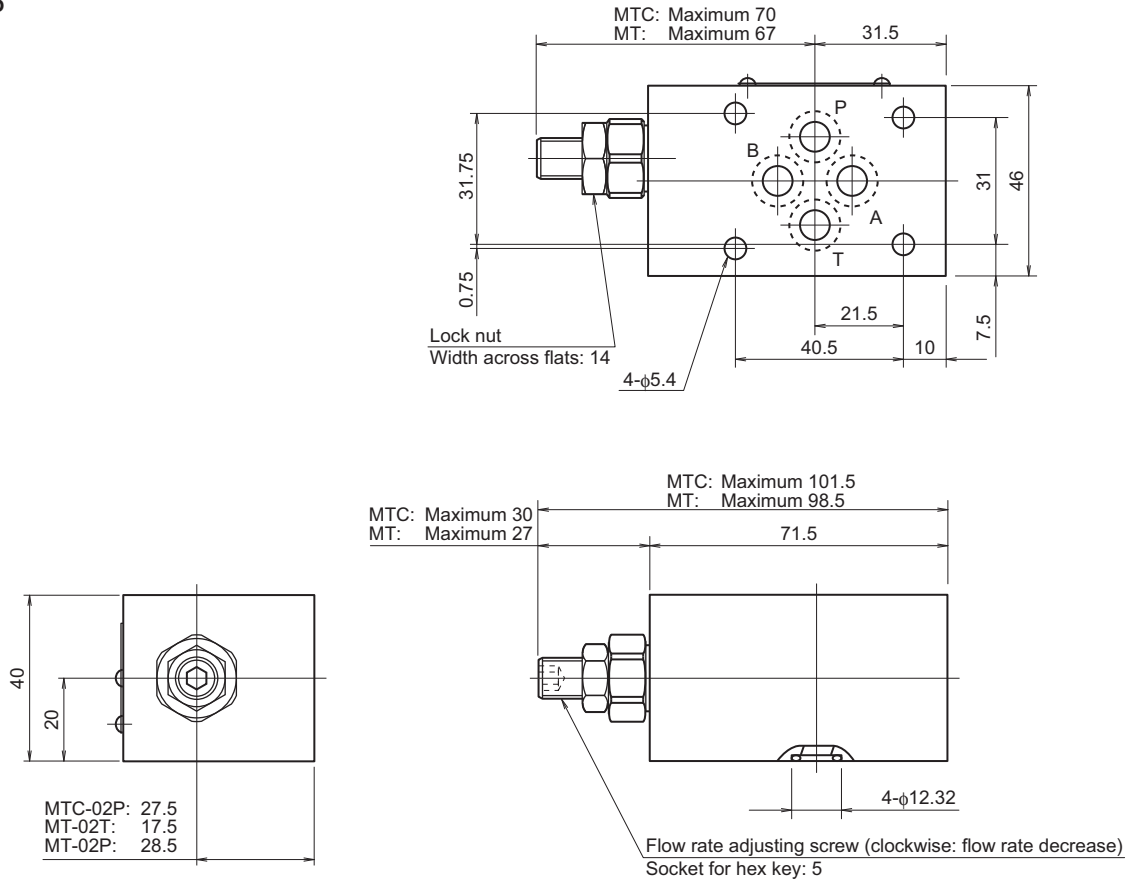

Sectional structural diagram

MT-02P-65
MT-02T-65

MTC-02P-55

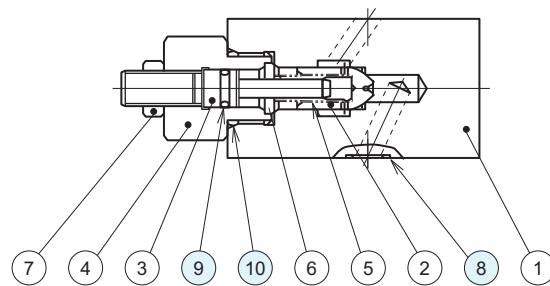
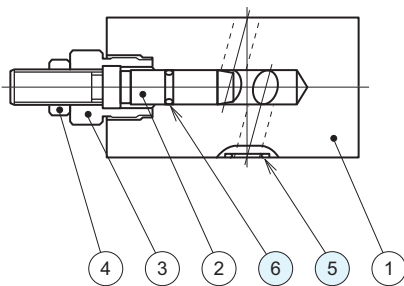

Sealing part table

Part No.	Name	Quantity	Part specifications
5	O-ring	4	AS568-012 (NBR, Hs90)
6	O-ring	1	JIS B 2401 1B P7

Sealing part table

Part No.	Name	Quantity	Part specifications
8	O-ring	4	AS568-012 (NBR, Hs90)
9	O-ring	1	JIS B 2401 1B P8
10	O-ring	1	JIS B 2401 1B P18