

## Contact Details

Before using the product, please check the guide pages at the front of this catalog.

Internet

<http://www.daikinpmc.com/en/>

For latest information, PDF catalogs and operation manuals

# Medium-pressure Cartridge Type Vane Pump

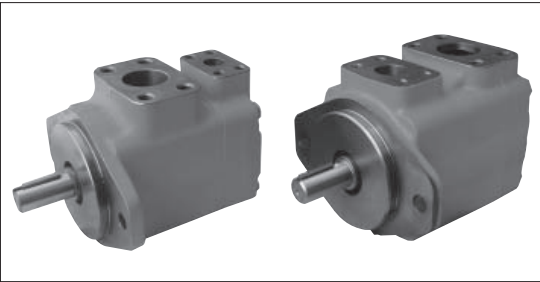

## Features

- The intra-vane type structure realizes a low noise level at high pressure. The cartridge type design offers reliable operation over a prolonged period. These vane pumps with a maximum pressure of 20.6 MPa are suited to various applications in industrial machinery.

VANE PUMPS

## Nomenclature

※ - DEV ※ ※ - ※ - ※ - ※ - 10  
 1 2 3 4 5 6 7

### 1 Applicable fluid code

No designation: Wear-resistant hydraulic fluid  
 Water-glycol hydraulic fluid  
 F: Phosphate ester hydraulic fluid

### 2 Model No.

DEV: Medium-pressure cartridge type vane pump

### 3 Pump capacity code

20: DEV20 ( 7 to 45 cm<sup>3</sup>/rev)  
 25: DEV25 ( 33 to 67 cm<sup>3</sup>/rev)  
 35: DEV35 ( 81 to 121 cm<sup>3</sup>/rev)  
 45: DEV45 (138 to 193 cm<sup>3</sup>/rev)

### 4 Pump capacity (cm<sup>3</sup>/rev)

DEV20	DEV25	DEV35	DEV45
2: 7	10: 33	25: 81	42: 138
5: 18	12: 40	30: 97	45: 147
8: 27	14: 45	35: 112	50: 162
9: 30	17: 55	38: 121	60: 193
11: 36	21: 67		
12: 39			
14: 45			

### 6 Installation types

No designation: Without foot support  
 B: Foot support mount

### 7 Design No.

(The design No. is subject to change)

### 5 Direction of rotation, when viewed from the shaft end

R: Clockwise (rightward)  
 L: Counterclockwise (leftward)

## Specifications and masses

Model No.	Displacement volume cm <sup>3</sup> /rev	Maximum pressure* MPa	Minimum pressure MPa	Minimum rotational speed min <sup>-1</sup>	Maximum rotational speed* min <sup>-1</sup>	Mass kg	
						Without foot support	With foot support
DEV20-2	7	13.8	0.7	600	1800	12.0	14.7
DEV20-5	18	20.6					
DEV20-8	27						
DEV20-9	30						
DEV20-11	36						
DEV20-12	39						
DEV20-14	45	13.8					
DEV25-10	33	17.2	0.7	600	1800	14.8	17.5
DEV25-12	40						
DEV25-14	45						
DEV25-17	55						
DEV25-21	67						
DEV35-25	81						
DEV35-30	97	22.7	28.6				
DEV35-35	112						
DEV35-38	121						
DEV45-42	138						
DEV45-45	147	34.0	39.9				
DEV45-50	162						
DEV45-60	193						

\* Values with wear-resistant hydraulic fluid

- Foot supports are not provided with the pump. Order them separately as required by referring to Page S-2.
- Refer to Pages D-31 and 32 for the conditions of use for models compatible with flame-resistant hydraulic oil and for other notes on handling.
- Refer to Page S-3 for the machining dimensions of coupling holes.

## External dimension diagram

### DEV20

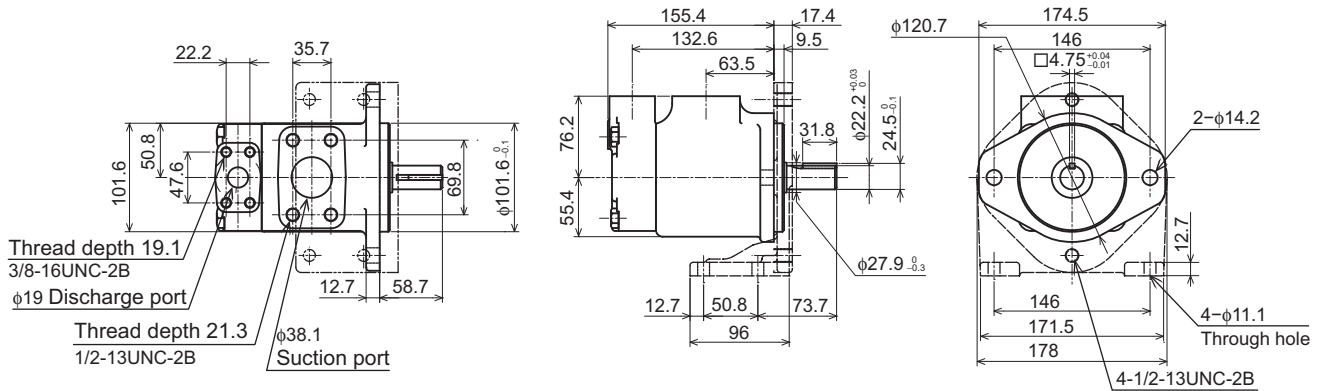

### DEV25, 35, 45

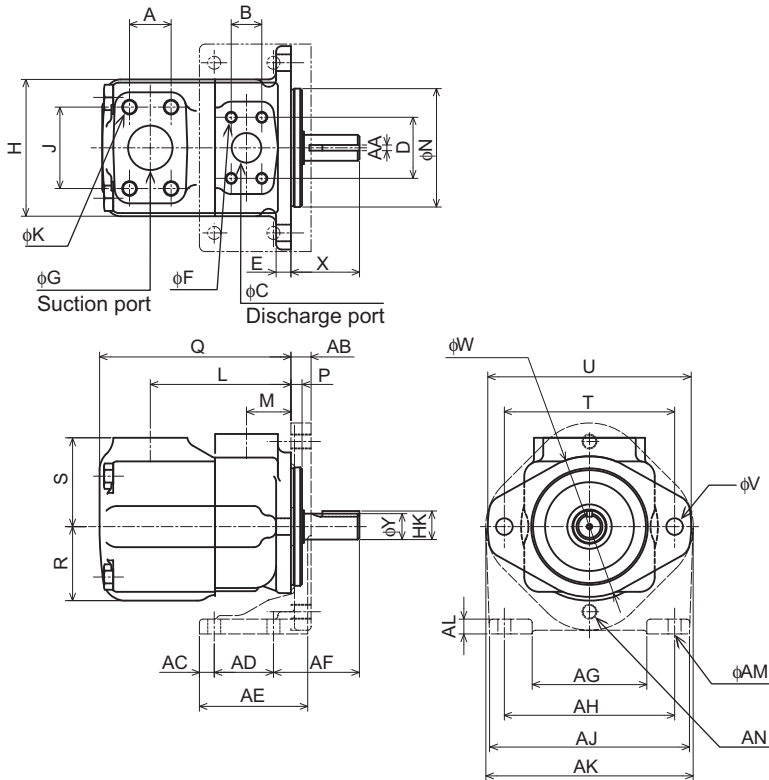

Model No.	$\phi F$	$\phi K$
DEV25	3/8-16UNC-2B Thread depth 19.1	1/2-13UNC-2B Thread depth 21.3
DEV35	7/16-14UNC-2B Thread depth 20.6	1/2-13UNC-2B Thread depth 23.9
DEV45	1/2-13UNC-2B Thread depth 23.9	5/8-11UNC-2B Thread depth 25.4

Model No.	DEV 25	DEV 35	DEV 45	Model No.	DEV 25	DEV 35	DEV 45
A	35.7	42.8	61.9	$\phi Y$	22.2 <sup>+0.03</sup>	31.7 <sup>+0.05</sup>	31.7 <sup>+0.05</sup>
B	26.2	30.1	35.7	HK	24.5 <sup>+0.1</sup>	35 <sup>+0.38</sup>	35 <sup>+0.38</sup>
$\phi C$	25.4	31.8	38.1	AA	4.75 <sup>+0.04</sup>	7.94 <sup>+0.02</sup>	7.94 <sup>+0.02</sup>
D	52.4	58.7	69.9	AB	12.7	19	19
E	12.7	15.7	16	AC	12.7	17.3	17.3
$\phi G$	38.1	50.8	76.2	AD	50.8	76.2	76.2
H	117	140	159	AE	96	131.6	131.6
J	69.9	77.7	106.3	AF	73.7	92.2	80.9
L	120.7	125.4	153.1	AG	98.3	164	164
M	38.1	38.1	42.9	AH	146	235	235
$\phi N$	101.6 <sup>+0.1</sup>	127 <sup>+0.1</sup>	127 <sup>+0.1</sup>	AJ	171.5	265	265
P	9.5	9.5	12.7	AK	178	213	213
Q	164	187	217	AL	12.7	15.7	15.7
R	63.5	69.8	82.6	$\phi AM$	11.1	17.3	17.3
S	76.2	82.6	93.6	AN	1/2-13UNC-2B	5/8-11UNC-2B	5/8-11UNC-2B
T	146	181	181		thread	thread	thread
U	175	213	213				
$\phi V$	14.2	17.5	17.5				
$\phi W$	120.7	147.6	147.6				
X	58.7	73.2	61.9				

○ The foot support mounting dimensions indicated in this diagram are the dimensions when the product is shipped with the foot support mounted. Note that they differ from the foot support dimensions given on Page S-2.

## Contact Details

Before using the product, please check the guide pages at the front of this catalog.

Internet

<http://www.daikinpmc.com/en/>

For latest information, PDF catalogs and operation manuals

## Sectional structural diagram

DEV20, 25, 35, 45

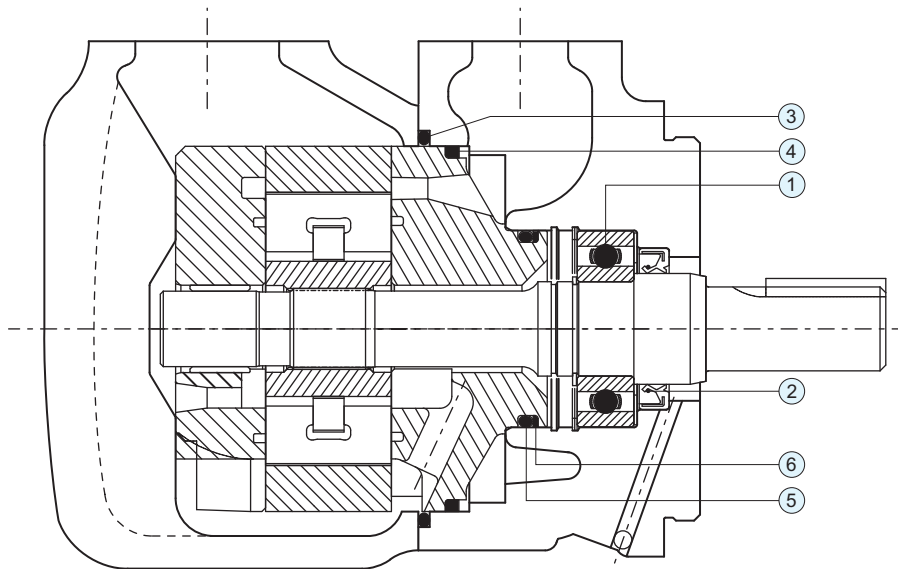

DEV20 Seal/bearing table

Part No.	Name	Specifications	Material	Quantity
1	Bearing	6204	—	1
2	Oil seal	Special part	NBR	1
3	O-ring	AS568-236 (HS70°)	NBR	1
4	Sealing ring	Special part	—	1
5	O-ring	AS568-222 (HS70°)	NBR	1
6	Backup ring	MS28774-222	PTFE	1

DEV35 Seal/bearing table

Part No.	Name	Specifications	Material	Quantity
1	Bearing	6306	—	1
2	Oil seal	Special part	NBR	1
3	O-ring	AS568-247 (HS70°)	NBR	1
4	Sealing ring	Special part	—	1
5	O-ring	AS568-230 (HS70°)	NBR	1
6	Backup ring	MS28744-146	PTFE	1

DEV25 Seal/bearing table

Part No.	Name	Specifications	Material	Quantity
1	Bearing	6205	—	1
2	Oil seal	Special part	NBR	1
3	O-ring	AS568-241 (HS70°)	NBR	1
4	Sealing ring	Special part	—	1
5	O-ring	AS568-224 (HS70°)	NBR	1
6	Backup ring	MS28774-224	PTFE	1

DEV45 Seal/bearing table

Part No.	Name	Specifications	Material	Quantity
1	Bearing	6307	—	1
2	Oil seal	Special part	NBR	1
3	O-ring	AS568-253 (HS70°)	NBR	1
4	Sealing ring	Special part	—	1
5	O-ring	AS568-233 (HS70°)	NBR	1
6	Backup ring	MS28744-233	PTFE	1

# Contact Details

Before using the product, please check the guide pages at the front of this catalog.

Internet

<http://www.daikinpmc.com/en/>

For latest information, PDF catalogs and operation manuals

## General performance Fluid used: viscosity of 26 mm<sup>2</sup>/s, Fluid temperature: 50°C

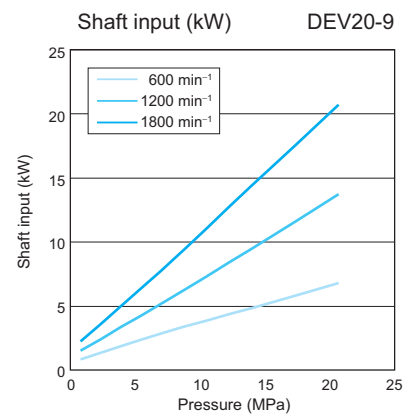
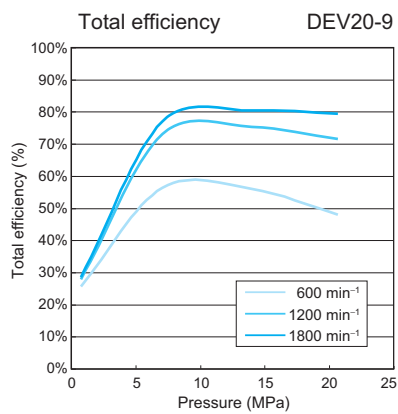
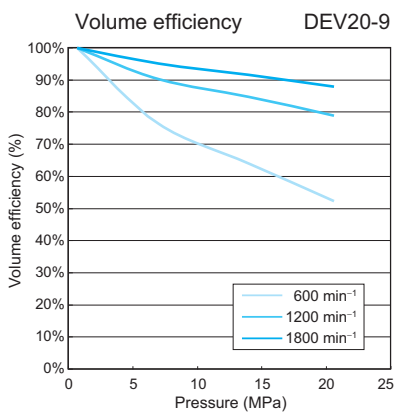
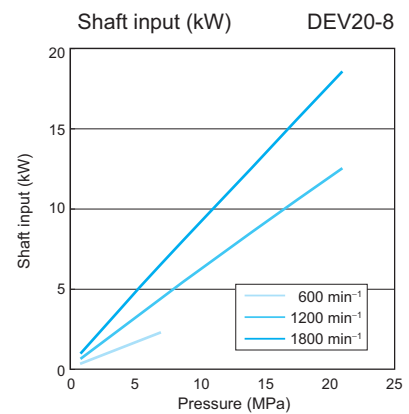
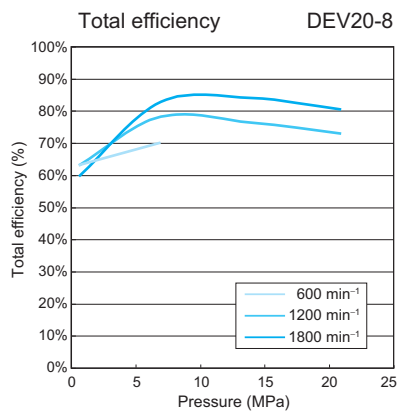
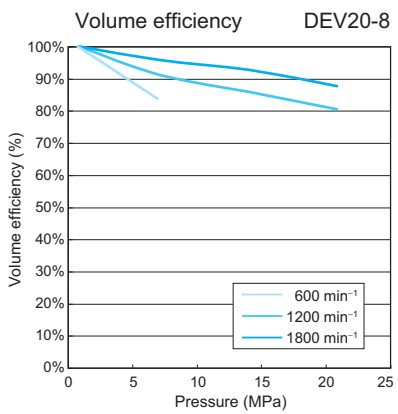
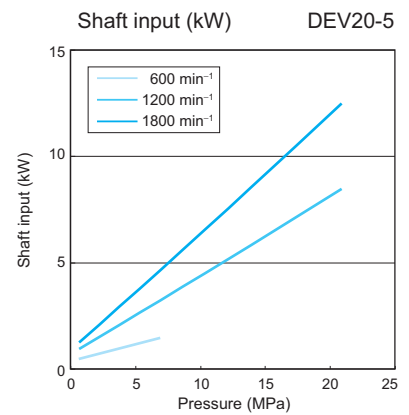
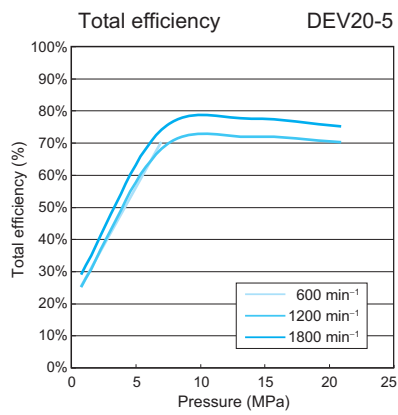
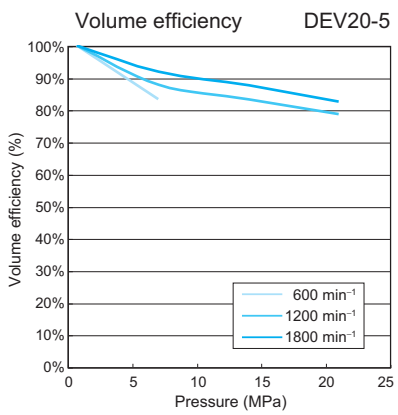
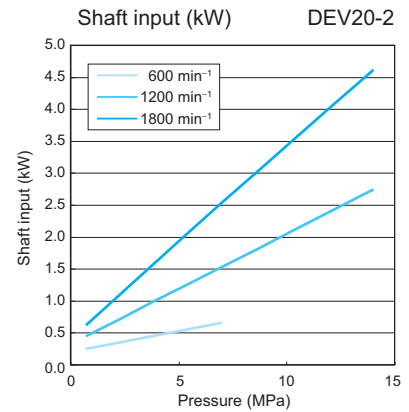
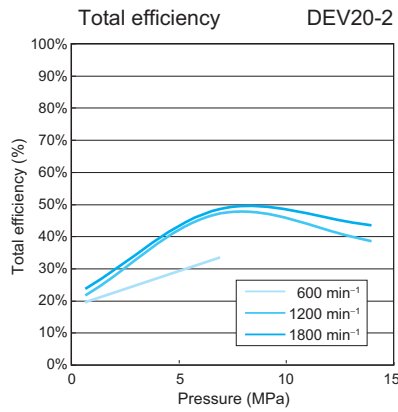
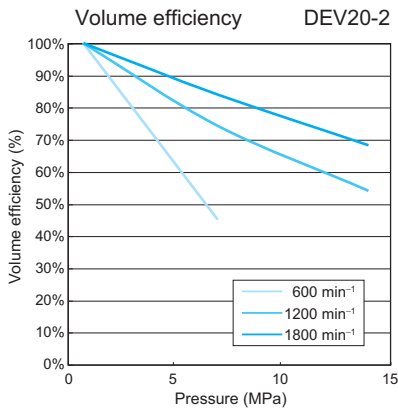

**General performance Fluid used: viscosity of 26 mm<sup>2</sup>/s, Fluid temperature: 50°C**

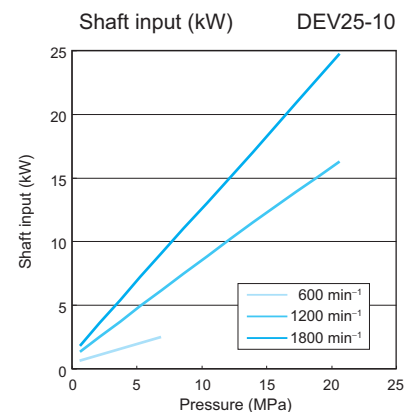
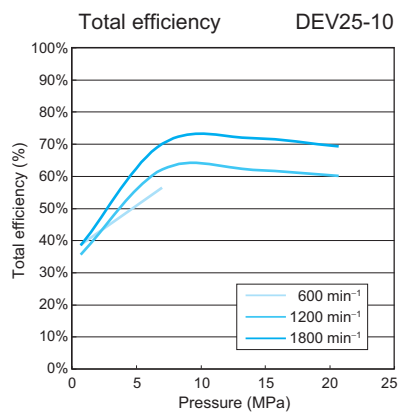
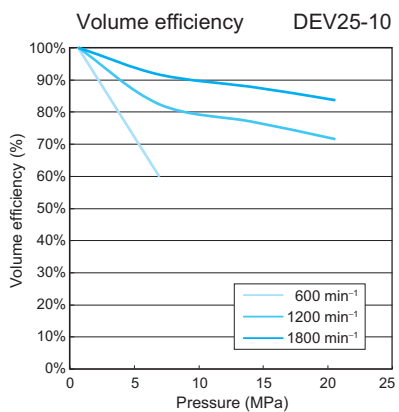
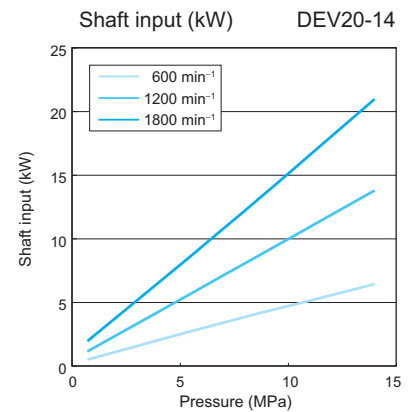
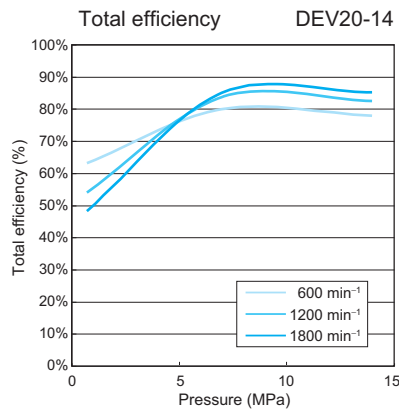
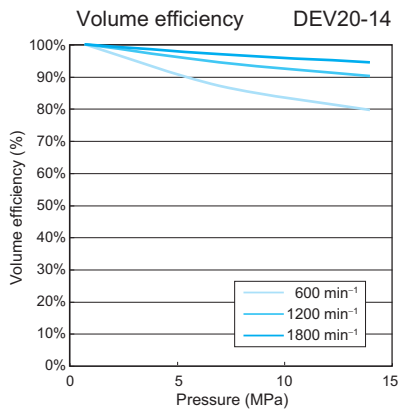
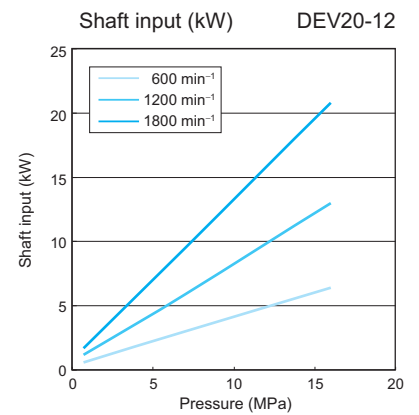
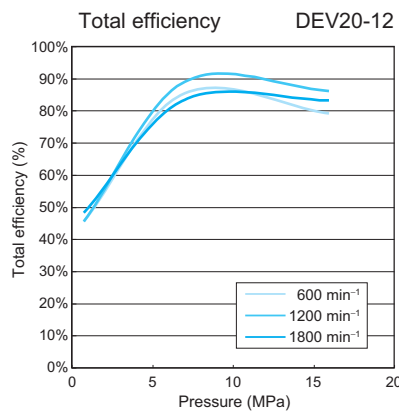
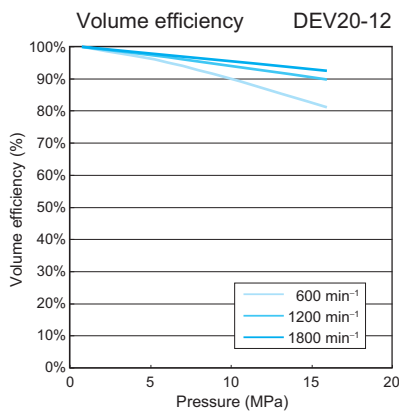
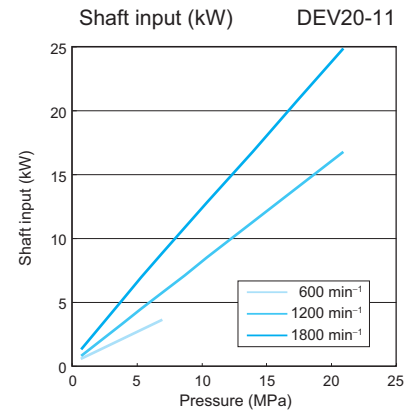
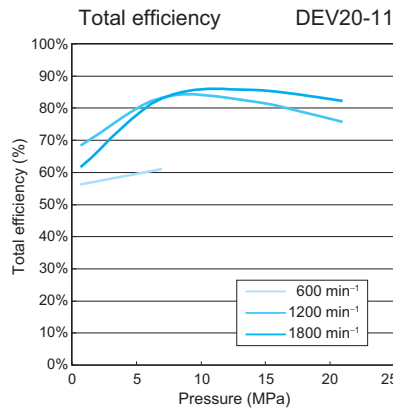
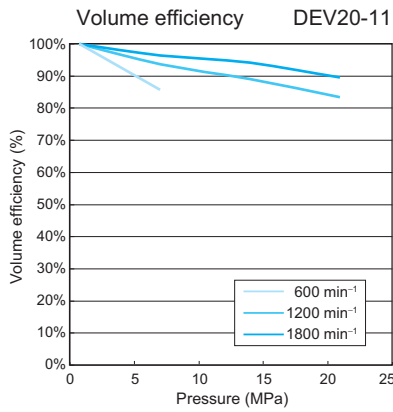

# Contact Details

Before using the product, please check the guide pages at the front of this catalog.

Internet

<http://www.daikinpmc.com/en/>

For latest information, PDF catalogs and operation manuals

## General performance Fluid used: viscosity of 26 mm<sup>2</sup>/s, Fluid temperature: 50°C

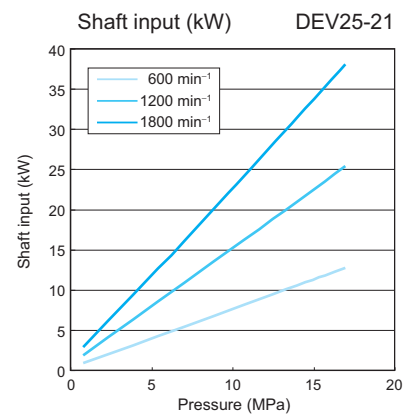
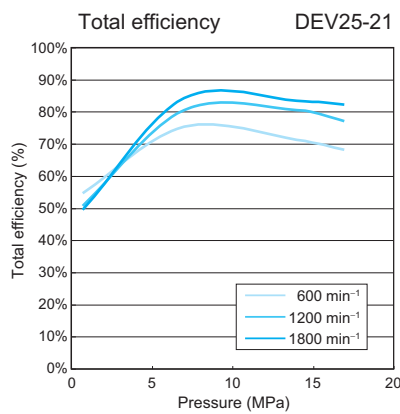
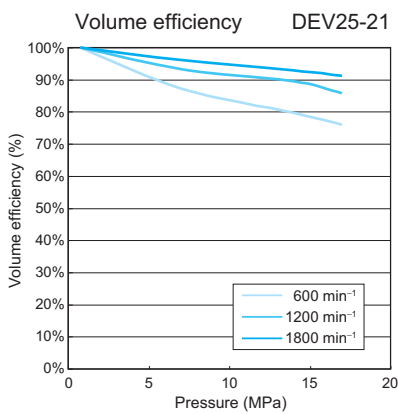
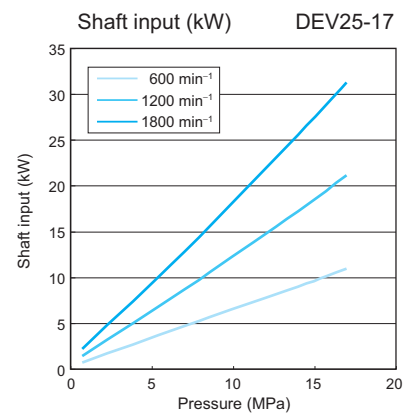
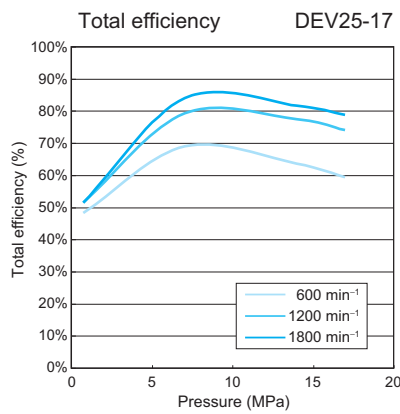
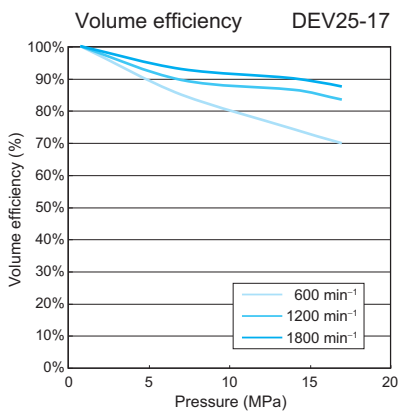
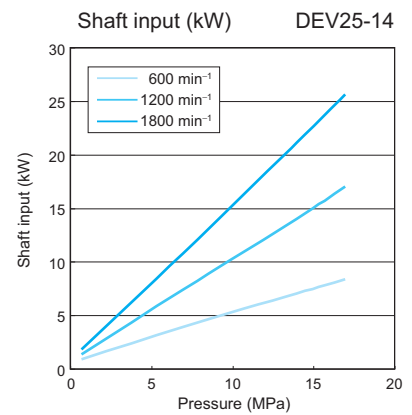
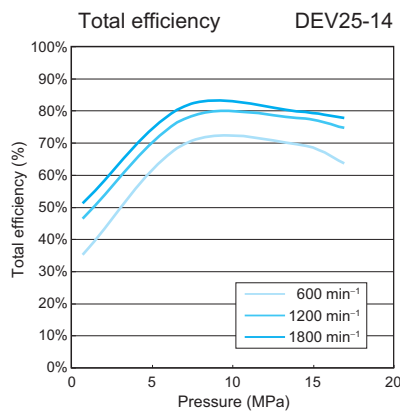
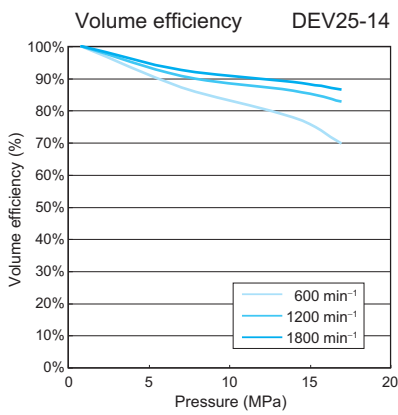
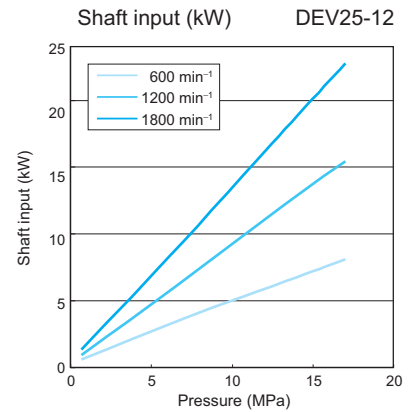
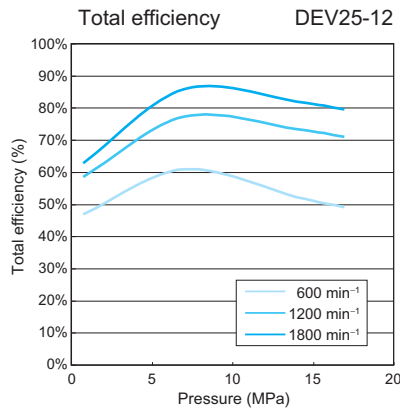
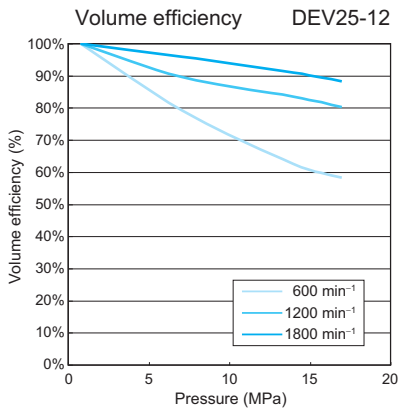

**General performance Fluid used: viscosity of 26 mm<sup>2</sup>/s, Fluid temperature: 50°C**

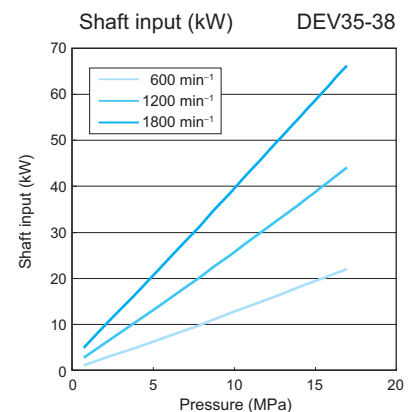
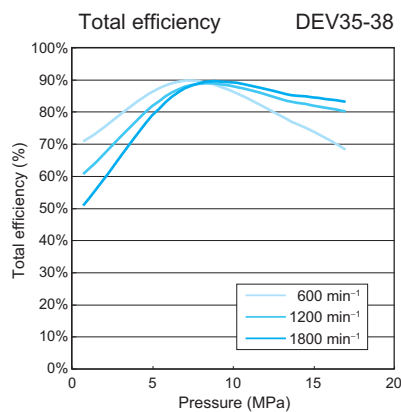
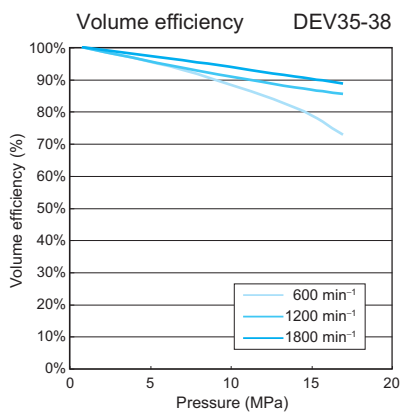
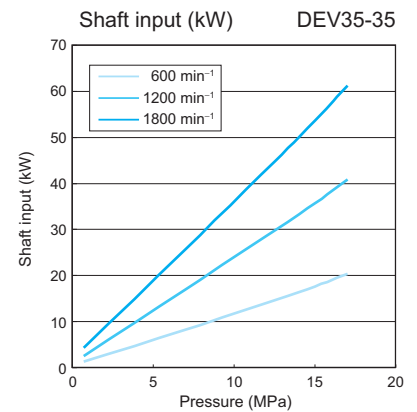
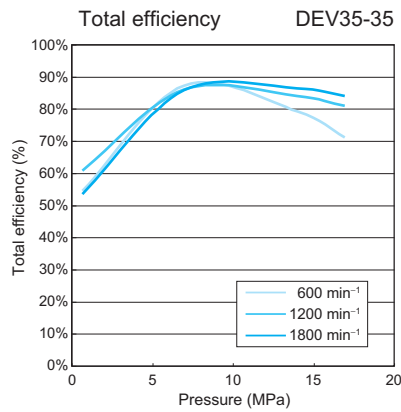
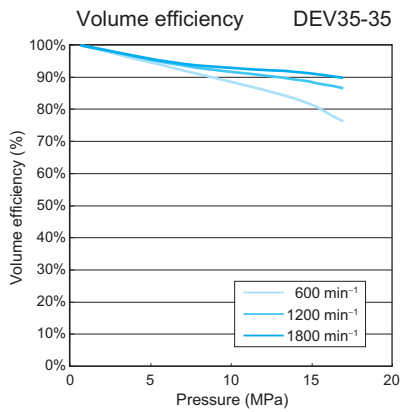
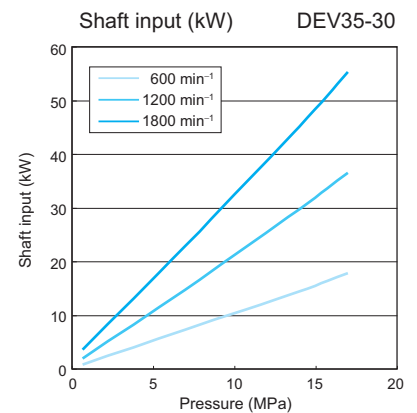
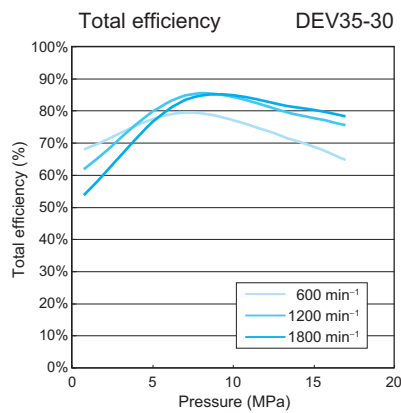
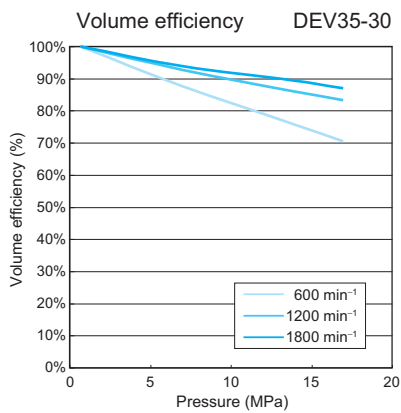
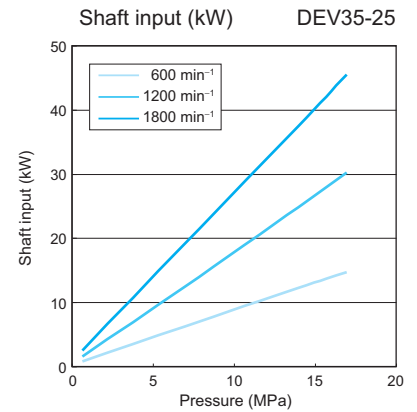
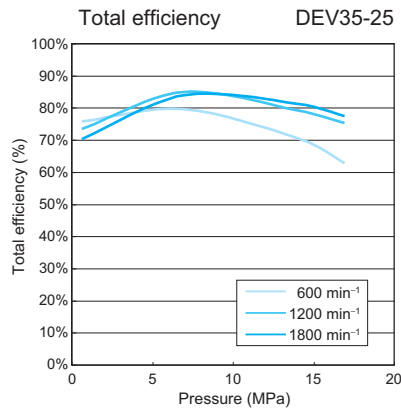
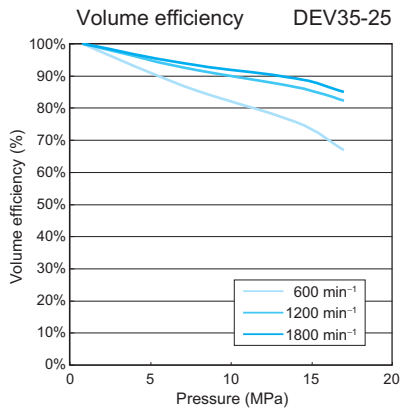

# Contact Details

Before using the product, please check the guide pages at the front of this catalog.

Internet

<http://www.daikinpmc.com/en/>

For latest information, PDF catalogs and operation manuals

## General performance Fluid used: viscosity of 26 mm<sup>2</sup>/s, Fluid temperature: 50°C

